

Technische Daten:  
Hygiene Schutz - VESPER

Datasheet:  
Hygiene protection - VESPER

Art. 77200680420-20  
Art. 77200680420-23

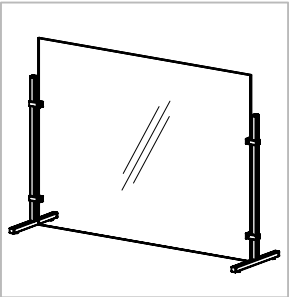

Ausführung:  
Options:

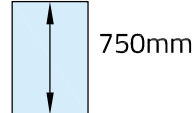
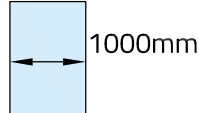
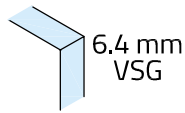

Material: V2A  
Material: Stainless steel AISI 304

Gewicht: / Weight: 13,3 kg

Oberflächen: Edelstahl-Design  
Finish: Stainless steel design

Chrom-Design  
Chrome design

Im Lieferumfang enthalten - Scope of supply

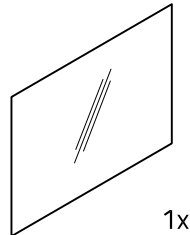
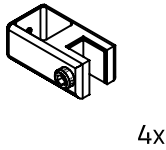
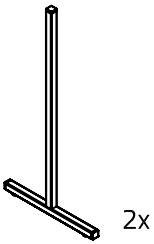

Montagewerkzeug - Mounting tools

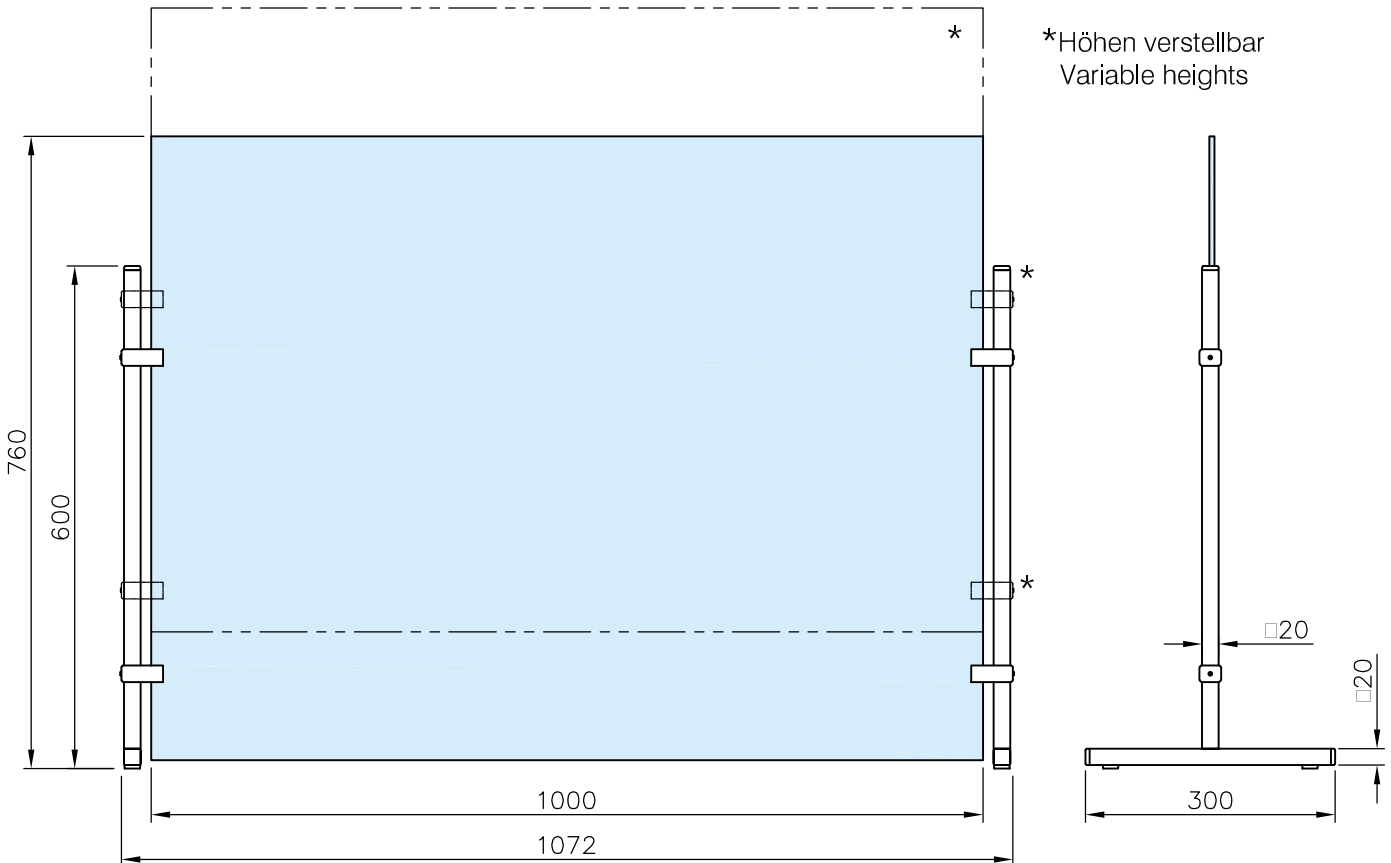
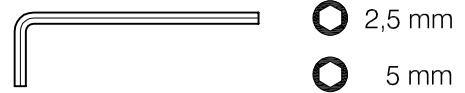

Art. 77200680420-20  
Art. 77200680420-23

Montage:  
Installation:

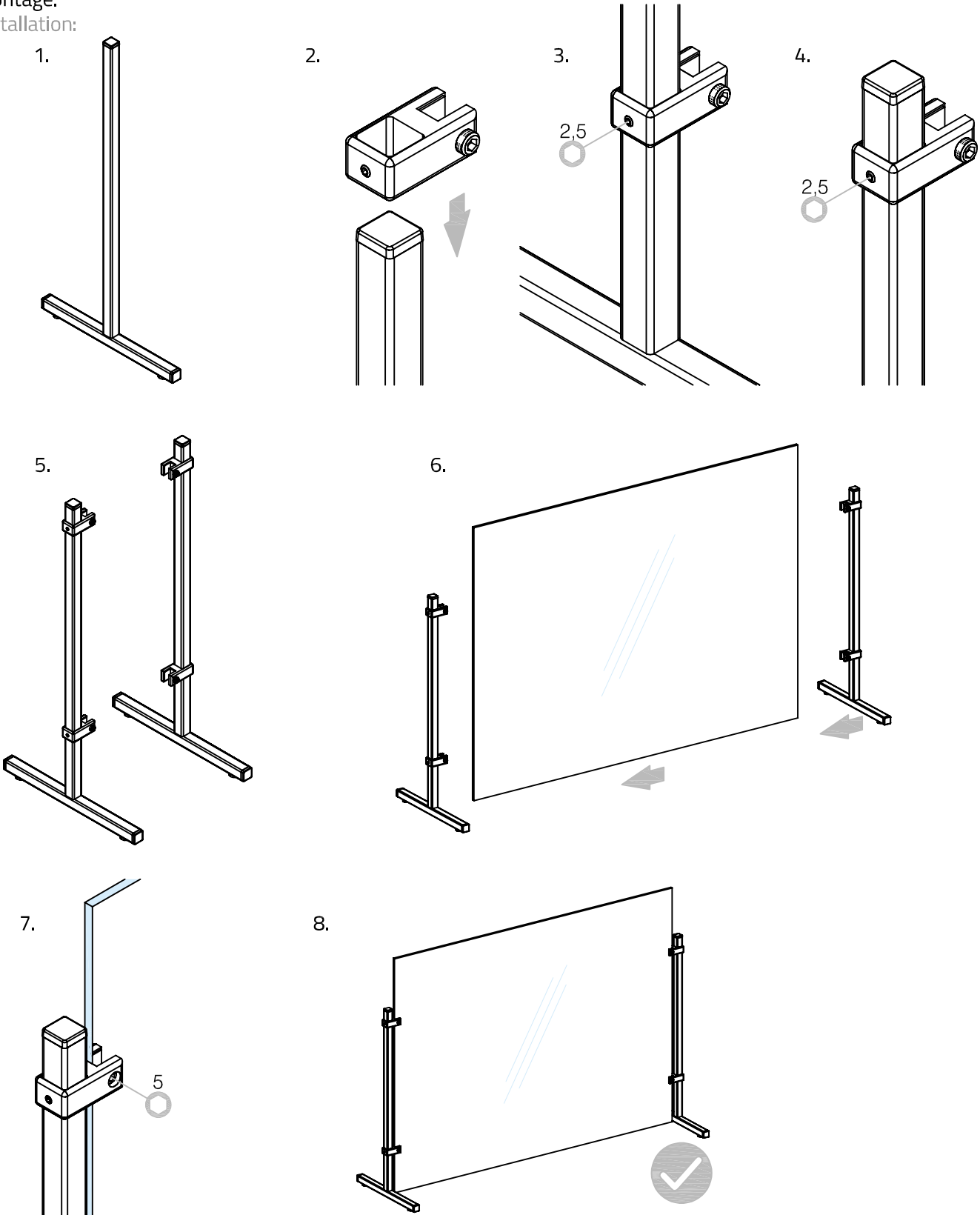

Art. 77200680420-20  
Art. 77200680420-23

Erweiterungen möglich:  
Extensions possible:

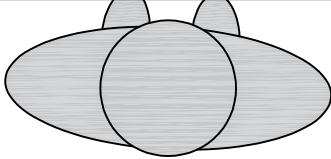
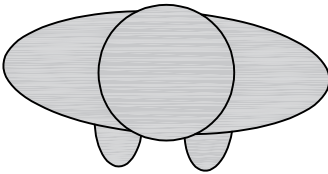
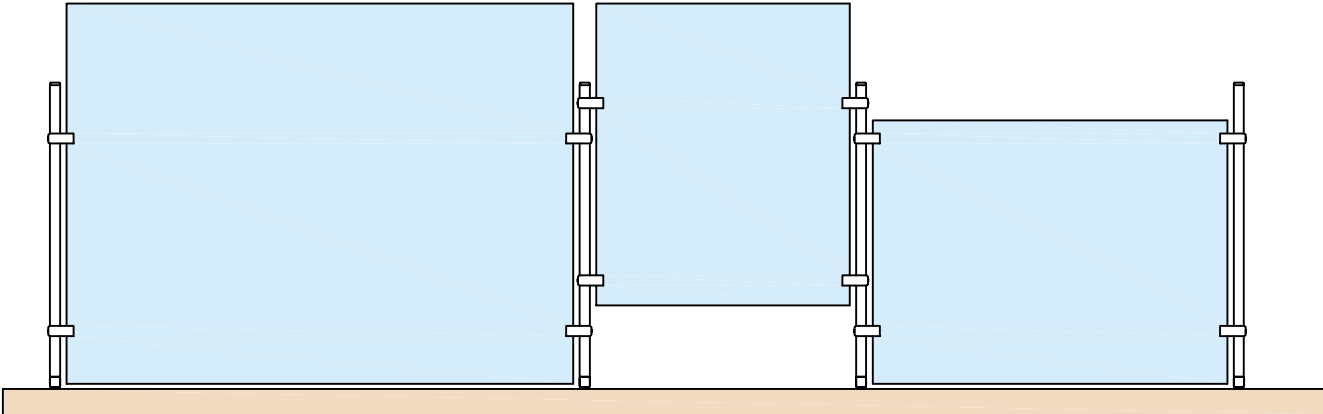

**G-FITTINGS GmbH**

Marie-Curie-Straße 16-18  
46446 Emmerich am Rhein  
T +49 (0)2822 962 0  
F +49 (0)2822 962 221  
E sales@g-fittings.com