

Technische Daten:
Hygiene Schutz - VESPER

Datasheet:
Hygiene protection - VESPER

Art. 77200681420-20
Art. 77200681420-23

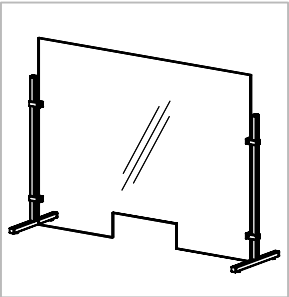

Ausführung:
Options:

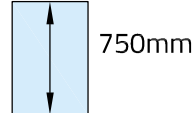
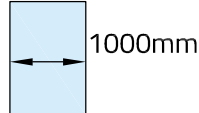
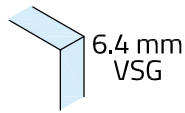

Material: V2A
Material: Stainless steel AISI 304

Gewicht: / Weight: 13,3 kg

Oberflächen:
Finish: Edelstahl-Design
Stainless steel design

Chrom-Design
Chrome design

Im Lieferumfang enthalten - Scope of supply

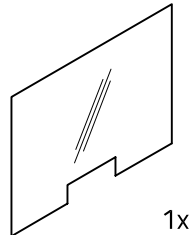
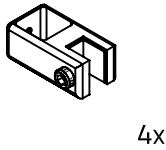
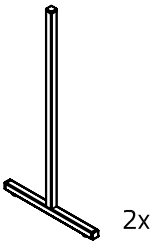

Montagewerkzeug - Mounting tools

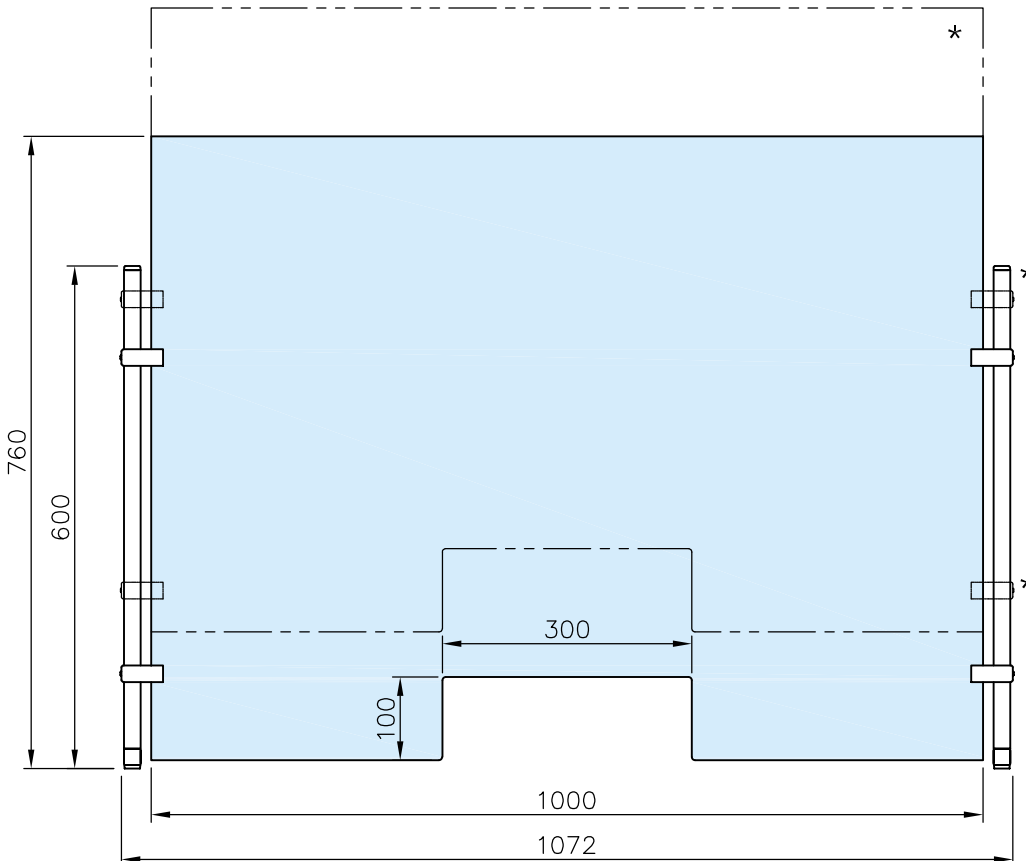
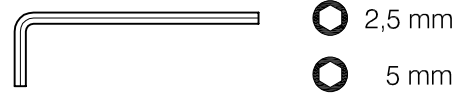

*Höhen verstellbar
Variable heights

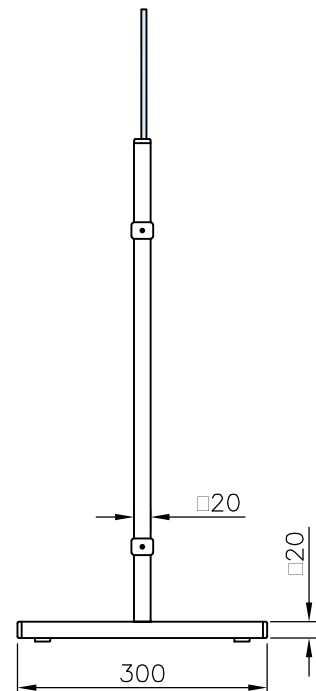

Art. 77200681420-20
Art. 77200681420-23

Montage:
Installation:

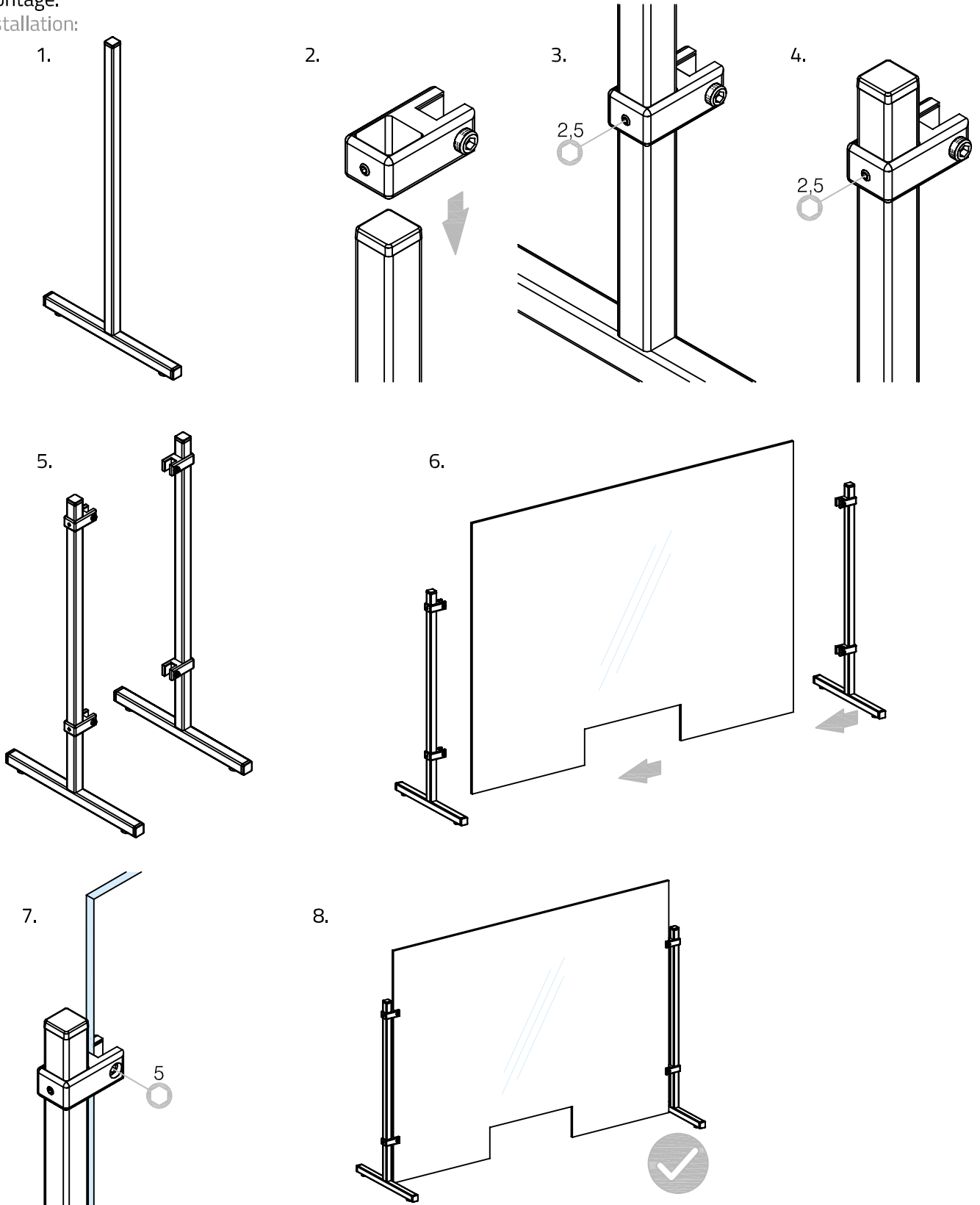

Art. 77200681420-20
Art. 77200681420-23

Erweiterungen möglich:
Extensions possible:

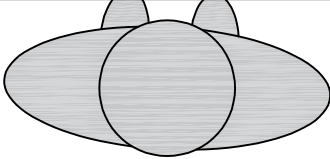
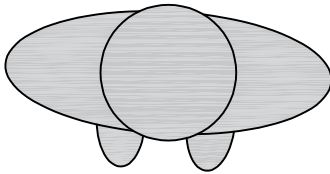
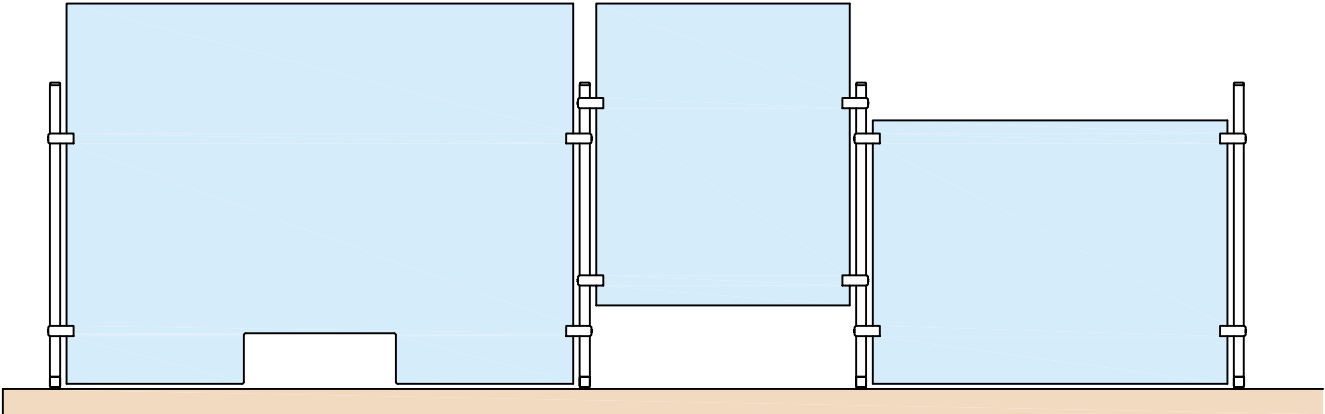

G-FITTINGS GmbH

Marie-Curie-Straße 16-18
46446 Emmerich am Rhein
T +49 (0)2822 962 0
F +49 (0)2822 962 221
E sales@g-fittings.com